

..... 1: Head Assembly Screws

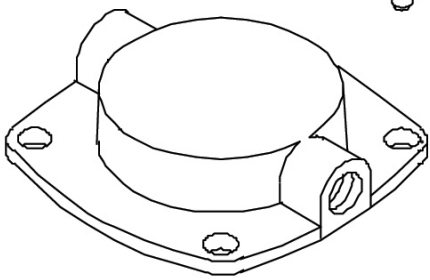

..... 2: Head Assembly

..... 3: Diaphragm Hold Down Screws

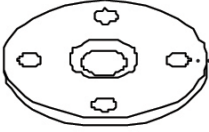

..... 4: Diaphragm Hold Down Plate

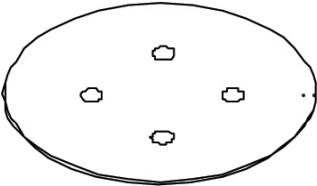

..... 5: Diaphragm liner, PTFE

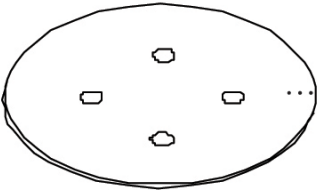

..... 6: Diaphragm, Buna N

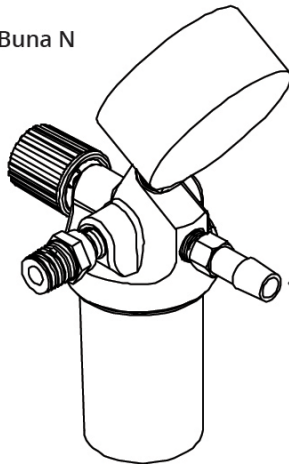
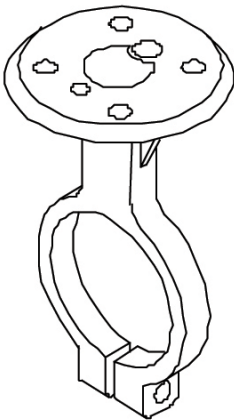

..... 7: Hose Barb PVDF
1/8" NPT x 1/4" ID Hose

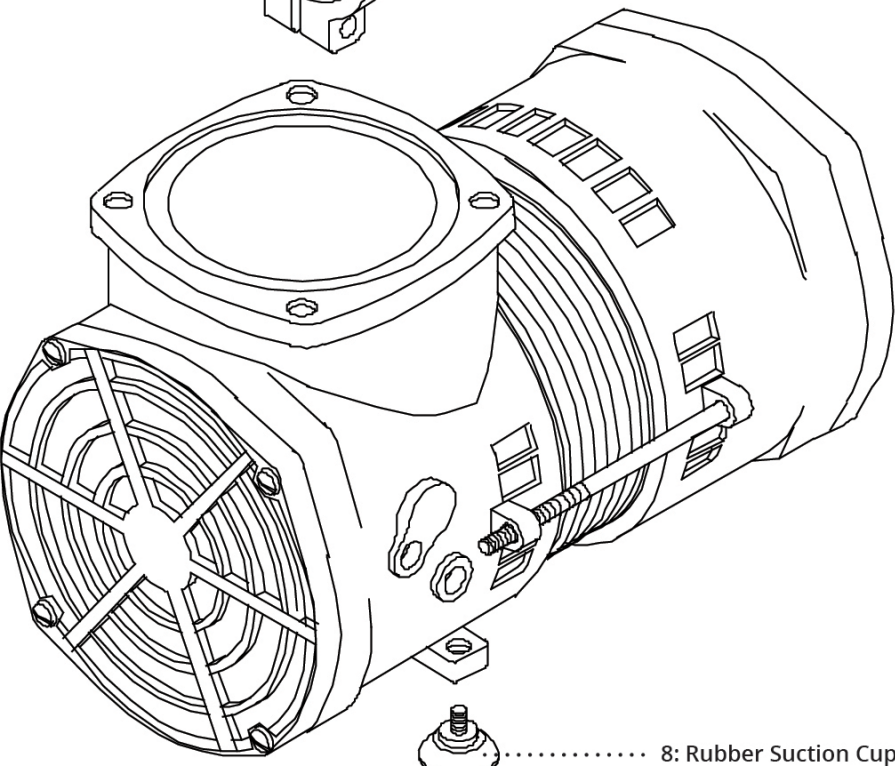

..... 8: Rubber Suction Cup Feet